

marantz®

Model SA-11S3 Owner's Manual

Super Audio CD player

SAFETY PRECAUTIONS



CAUTION
RISK OF ELECTRIC SHOCK
DO NOT OPEN



CAUTION:
TO REDUCE THE RISK OF ELECTRIC SHOCK, DO NOT REMOVE COVER (OR BACK). NO USER-SERVICEABLE PARTS INSIDE. REFER SERVICING TO QUALIFIED SERVICE PERSONNEL.

The lightning flash with arrowhead symbol, within an equilateral triangle, is intended to alert the user to the presence of uninsulated "dangerous voltage" within the product's enclosure that may be of sufficient magnitude to constitute a risk of electric shock to persons.

The exclamation point within an equilateral triangle is intended to alert the user to the presence of important operating and maintenance (servicing) instructions in the literature accompanying the appliance.

WARNING:
TO REDUCE THE RISK OF FIRE OR ELECTRIC SHOCK, DO NOT EXPOSE THIS APPLIANCE TO RAIN OR MOISTURE.

CAUTION:
USE OF CONTROLS OR ADJUSTMENTS OR PERFORMANCE OF PROCEDURES OTHER THAN THOSE SPECIFIED HEREIN MAY RESULT IN HAZARDOUS RADIATION EXPOSURE. THIS PRODUCT SHOULD NOT BE ADJUSTED OR REPAIRED BY ANYONE EXCEPT PROPERLY QUALIFIED SERVICE PERSONNEL.

CLASS 1 LASER PRODUCT

"CLASS 1
LASER PRODUCT"

IMPORTANT SAFETY INSTRUCTIONS

1. Read these instructions.
2. Keep these instructions.
3. Heed all warnings.
4. Follow all instructions.
5. Do not use this apparatus near water.
6. Clean only with dry cloth.
7. Do not block any ventilation openings. Install in accordance with the manufacturer's instructions.
8. Do not install near any heat sources such as radiators, heat registers, stoves, or other apparatus (including amplifiers) that produce heat.
9. Do not defeat the safety purpose of the polarized or grounding-type plug. A polarized plug has two blades with one wider than the other. A grounding type plug has two blades and a third grounding prong. The wide blade or the third prong are provided for your safety. If the provided plug does not fit into your outlet, consult an electrician for replacement of the obsolete outlet.
10. Protect the power cord from being walked on or pinched particularly at plugs, convenience receptacles, and the point where they exit from the apparatus.
11. Only use attachments/accessories specified by the manufacturer.
12. Use only with the cart, stand, tripod, bracket, or table specified by the manufacturer, or sold with the apparatus. When a cart is used, use caution when moving the cart/apparatus combination to avoid injury from tip-over.
13. Unplug this apparatus during lightning storms or when unused for long periods of time.
14. Refer all servicing to qualified service personnel. Servicing is required when the apparatus has been damaged in any way, such as power-supply cord or plug is damaged, liquid has been spilled or objects have fallen into the apparatus, the apparatus has been exposed to rain or moisture, does not operate normally, or has been dropped.
15. Batteries shall not be exposed to excessive heat such as sunshine, fire or the like.



CAUTION:

To completely disconnect this product from the mains, disconnect the plug from the wall socket outlet. The mains plug is used to completely interrupt the power supply to the unit and must be within easy access by the user.

PRECAUTION:

Pour déconnecter complètement ce produit du courant secteur, débranchez la prise de la prise murale.

La prise secteur est utilisée pour couper complètement l'alimentation de l'appareil et l'utilisateur doit pouvoir y accéder facilement.

PRECAUCIÓN:

Para desconectar completamente este producto de la alimentación eléctrica, desconecte el enchufe del enchufe de la pared.

El enchufe de la alimentación eléctrica se utiliza para interrumpir por completo el suministro de alimentación eléctrica a la unidad y debe de encontrarse en un lugar al que el usuario tenga fácil acceso.

FCC INFORMATION (For US customers)

1. PRODUCT

This product complies with Part 15 of the FCC Rules. Operation is subject to the following two conditions: (1) this product may not cause harmful interference, and (2) this product must accept any interference received, including interference that may cause undesired operation.

2. IMPORTANT NOTICE: DO NOT MODIFY THIS PRODUCT

This product, when installed as indicated in the instructions contained in this manual, meets FCC requirements. Modification not expressly approved by marantz may void your authority, granted by the FCC, to use the product.

3. NOTE

This product has been tested and found to comply with the limits for a Class B digital device, pursuant to Part 15 of the FCC Rules. These limits are designed to provide reasonable protection against harmful interference in a residential installation.

This product generates, uses and can radiate radio frequency energy and, if not installed and used in accordance with the instructions, may cause harmful interference to radio communications. However, there is no guarantee that interference will not occur in a particular installation. If this product does cause harmful interference to radio or television reception, which can be determined by turning the product OFF and ON, the user is encouraged to try to correct the interference by one or more of the following measures:

- Reorient or relocate the receiving antenna.
- Increase the separation between the equipment and receiver.
- Connect the product into an outlet on a circuit different from that to which the receiver is connected.
- Consult the local retailer authorized to distribute this type of product or an experienced radio/TV technician for help.

For Canadian customers:

This Class B digital apparatus complies with Canadian ICES-003. Cet appareil numérique de la classe B est conforme à la norme NMB-003 du Canada.

NOTE ON USE / OBSERVATIONS RELATIVES A L'UTILISATION / NOTAS SOBRE EL USO

WARNINGS	AVERTISSEMENTS	ADVERTENCIAS
<ul style="list-style-type: none"> • Avoid high temperatures. Allow for sufficient heat dispersion when installed in a rack. • Handle the power cord carefully. Hold the plug when unplugging the cord. • Keep the unit free from moisture, water, and dust. • Unplug the power cord when not using the unit for long periods of time. • Do not obstruct the ventilation holes. • Do not let foreign objects into the unit. • Do not let insecticides, benzene, and thinner come in contact with the unit. • Never disassemble or modify the unit in any way. • Ventilation should not be impeded by covering the ventilation openings with items, such as newspapers, tablecloths or curtains. • Naked flame sources such as lighted candles should not be placed on the unit. • Observe and follow local regulations regarding battery disposal. • Do not expose the unit to dripping or splashing fluids. • Do not place objects filled with liquids, such as vases, on the unit. • Do not handle the mains cord with wet hands. • When the switch is in the OFF position, the equipment is not completely switched off from MAINS. • The equipment shall be installed near the power supply so that the power supply is easily accessible. • Do not keep the battery in a place exposed to direct sunlight or in places with extremely high temperatures, such as near a heater. 	<ul style="list-style-type: none"> • Eviter des températures élevées. Tenir compte d'une dispersion de chaleur suffisante lors de l'installation sur une étagère. • Manipuler le cordon d'alimentation avec précaution. Tenir la prise lors du débranchement du cordon. • Protéger l'appareil contre l'humidité, l'eau et la poussière. • Débrancher le cordon d'alimentation lorsque l'appareil n'est pas utilisé pendant de longues périodes. • Ne pas obstruer les trous d'aération. • Ne pas laisser des objets étrangers dans l'appareil. • Ne pas mettre en contact des insecticides, du benzène et un diluant avec l'appareil. • Ne jamais démonter ou modifier l'appareil d'une manière ou d'une autre. • Ne pas recouvrir les orifices de ventilation avec des objets tels que des journaux, nappes ou rideaux. Cela entraverait la ventilation. • Ne jamais placer de flamme nue sur l'appareil, notamment des bougies allumées. • Veuillez à respecter les lois en vigueur lorsque vous jetez les piles usagées. • L'appareil ne doit pas être exposé à l'eau ou à l'humidité. • Ne pas poser d'objet contenant du liquide, par exemple un vase, sur l'appareil. • Ne pas manipuler le cordon d'alimentation avec les mains mouillées. • Lorsque l'interrupteur est sur la position OFF, l'appareil n'est pas complètement déconnecté du SECTEUR (MAINS). • L'appareil sera installé près de la source d'alimentation, de sorte que cette dernière soit facilement accessible. • Ne placez pas la pile dans un endroit exposé à la lumière directe du soleil ou dans des endroits présentant des températures extrêmement élevées, par exemple près d'un radiateur. 	<ul style="list-style-type: none"> • Evite altas temperaturas. Permite la suficiente dispersión del calor cuando está instalado en la consola. • Maneje el cordón de energía con cuidado. Sostenga el enchufe cuando desconecte el cordón de energía. • Mantenga el equipo libre de humedad, agua y polvo. • Desconecte el cordón de energía cuando no utilice el equipo por mucho tiempo. • No obstruya los orificios de ventilación. • No deje objetos extraños dentro del equipo. • No permita el contacto de insecticidas, gasolina y diluyentes con el equipo. • Nunca desarme o modifique el equipo de ninguna manera. • La ventilación no debe quedar obstruida por haberse cubierto las aperturas con objetos como periódicos, manteles o cortinas. • No deberán colocarse sobre el aparato fuentes inflamables sin protección, como velas encendidas. • A la hora de deshacerse de las pilas, respete la normativa para el cuidado del medio ambiente. • No exponer el aparato al goteo o salpicaduras cuando se utilice. • No colocar sobre el aparato objetos llenos de líquido, como jarras. • No maneje el cable de alimentación con las manos mojadas. • Cuando el interruptor está en la posición OFF, el equipo no está completamente desconectado de la alimentación MAINS. • El equipo se instalará cerca de la fuente de alimentación de manera que resulte fácil acceder a ella. • No coloque las pilas en un lugar expuesto a la luz directa del sol o donde la temperatura sea extremadamente alta, como cerca de una calefacción.

CAUTIONS ON INSTALLATION PRÉCAUTIONS D'INSTALLATION EMPLAZAMIENTO DE LA INSTALACIÓN

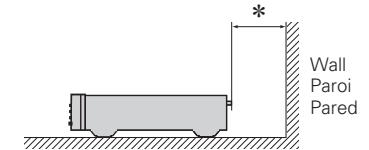
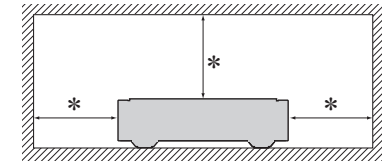

*** For proper heat dispersal, do not install this unit in a confined space, such as a bookcase or similar enclosure.**

- More than 4 in. (0.1 m) is recommended.
- Do not place any other equipment on this unit.

*** Pour permettre la dissipation de chaleur requise, n'installez pas cette unité dans un espace confiné tel qu'une bibliothèque ou un endroit similaire.**

- Une distance de plus de 4 in. (0.1 m) est recommandée.
- Ne placez aucun matériel sur cet appareil.

*** Para la dispersión del calor adecuadamente, no instale este equipo en un lugar confinado tal como una librería o unidad similar.**

- Se recomienda dejar más de 4 in. (0.1 m) alrededor.
- No coloque ningún otro equipo sobre la unidad.

Getting started

Thank you for purchasing this marantz product. To ensure proper operation, please read this owner's manual carefully before using the product. After reading the manual, be sure to keep it for future reference.

Contents

Getting started	1	Operation	12	Menu settings	22
Main features	2	Before use	12	Timer Play (Timer play setting)	22
Accessories	2	Power ON	12	Play File (Play range setting)	23
About this manual	2	Switching the input source	12	Disp Info (file information display selection)	23
Cautions on handling	3	Switching the sound mode (Playback layer)	12	iPod Ctrl (Switch the iPod operation mode)	23
Discs	3	Playback CDs	13	USB Resume	
Discs playable on this unit	3	Playing Super Audio CDs or CDs	13	(Playing tracks from where they were previously stopped)	24
Holding discs	3	Having the display and the illumination lamp off	14	Digital Out (Setting for the digital output)	24
Loading discs	3	Having the illumination lamp always off	14	Phase (analog output phase switching)	24
Cautions on loading discs	3	Display switching	14	Auto Stnby (Auto standby mode)	24
Cautions on handling	4	Listening with headphone	14		
Cautions on storing discs	4	Playing repeatedly (Repeat Playback)	14		
Cleaning discs	4	Playing in random order (Random playback)	15		
About the remote control	4	Playing tracks in a specific order			
Inserting the batteries	4	(Program playback)	15		
Operating range of the remote control	4	Stopping digital outputs	15		
Part names and functions	5	Playback of MP3 and WMA files	16		
Front panel	5	MP3 and WMA formats	16		
Display	5	MP3 and WMA file playback	16		
Rear panel	6	MP3 or WMA playback order of MP3 or WMA files	16		
Remote control	7	Playback iPod®	17		
		Playing an iPod®	17		
		Disconnecting the iPod	17		
		Playing a USB memory device	18		
		Playable USB memory formats	18		
		Playing files stored on USB memory devices	18		
		Removing the USB memory device	19		
		Using as a D/A converter	20		
		Connect and playback from a digital device (Coaxial/Optical)	20		
		Connecting and playing back from a computer (USB)	20		
		Specifying the desired sound quality	21		
		Noise shaper function	21		
		DC filter function	21		
		Switching the filter characteristics	21		
Basic connections	8			Explanation of terms	25
Preparations	8				
Connecting cables	8			Troubleshooting	26
Analog connections (UNBALANCED)	8				
Analog connections (BALANCED)	9			Specifications	28
Digital connection	9				
Digital audio output	9			Index	29
Digital audio input	9				
USB memory device / iPod connection	10				
PC connection	11				
Remote control connection	11				
Connecting the power cord	11				

Main features

Toroidal transformer

This unit features a toroidal transformer that produces less vibration and magnetic leakage flux compared to conventional power transformers. The materials and manufacturing process of the ring-shaped core are strictly controlled to reduce vibration, while the short-ring attached to the perimeter of the transformer reduce magnetic leakage flux.

Large-capacitance block capacitor

A large capacitance 4700 μ F capacitor carefully selected for its acoustic characteristics is incorporated into the power supply circuit.

Audiophile-grade film capacitors and electrolytic capacitors

The unit's features the same audiophile-grade film capacitors and electrolytic capacitors specifically used in top-range models.

Low-noise low-distortion filter circuit and highspeed HDAMSA2-type output amplifier with the differential input type HDAM

Double-layered chassis

High-grade machined analog audio output connectors

Playback of CD-R/CD-RW discs

Playback of CD-R/CD-RW/CD-ROM discs (MP3/WMA) and USB audio (MP3/WMA/WAV/AAC)/iPod

Can be used as a D/A converter

Digital audio signals input from an external device or computer into this unit can be converted and output as analog signals using this unit's D/A converter.

Inverted-phase analog output signal is possible

The USA system balanced output of this unit can be inverted to permit a balanced input to a European type amplifier.

Peripheral circuitry off function minimizes audio output signal interference

In order to minimize noise from peripheral circuitry which could interfere with the analog audio signal, this unit is equipped with a peripheral circuitry off function which turns off the digital output circuit, the headphones output circuit, the display, and the illumination lamp.

Filter switching function

Switching between 2 types of filter characteristics is possible during playback in the Super Audio CD and CD/DAC modes, allowing the listener to enjoy different shadings of the music.

Accessories

Check that the following parts are supplied with the product.

① Owner's manual.....	1
② Warranty card (for USA).....	1
③ Warranty card (for CANADA)	1
④ Power cord.....	1
⑤ Audio cable	1
⑥ Remote control cable.....	1
⑦ Remote control (RC001PMSA)	1
⑧ R03/AAA batteries	2

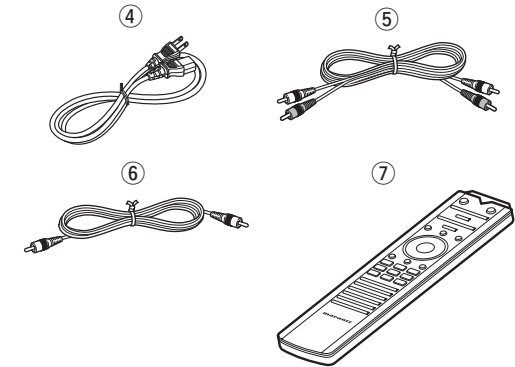

About this manual

❑ Operation buttons

The operations described in this manual are based mainly on remote control operation.

❑ Symbols



This symbol indicates a reference page on which related information is described.



This symbol indicates a supplementary information and tips for operations.

NOTE

This symbol indicates points to remember operations or function limitations.

❑ Illustrations

Note that the illustrations in these instructions are for explanation purposes and may differ from the actual unit.

Cautions on handling

• Before turning the power switch on

Check once again that all connections are correct and that there are no problems with the connection cables.

- When leaving home for long periods of time, be sure to unplug the power cord from the power outlet.

• Proper ventilation

If the unit is left in a room full of the smoke from cigarettes, etc., for long periods of time, the surface of the optical pickup may get dirty, preventing it from receiving the signals properly.

• About condensation

If there is a major difference in temperature between the inside of the unit and its surroundings, condensation may form on parts inside the unit, causing the unit to fail to operate properly.

If this happens, let the unit sit for an hour or two with the power off and wait until there is little difference in temperature before using the unit.

• Cautions on using mobile phones

Using a mobile phone near this unit may result in noise. If that occurs, move the mobile phone away from the unit when it is in use.

• Moving the unit

Turn off the power and unplug the power cord from the power outlet.

Next, disconnect the cables connected to other system units before moving the unit.

Discs

Discs playable on this unit

① Super Audio CDs

Super Audio CDs with the following logos indicated below can be played on this unit.



SUPER AUDIO CD

② Music CDs

Discs marked with the logo at right can be played in this unit.

③ CD-R/CD-RW

NOTE

- Discs in special shapes (heart-shaped discs, octagonal discs, etc.) cannot be played. Do not attempt to play them, as doing so can damage the unit.
- Some discs and some recording formats cannot be played.
- Non-finalized discs cannot be played.



* What is finalization?

Finalization is the process that makes recorded CD-R/CD-RW discs playable on compatible players.

Holding discs



Do not touch the signal surface.

Loading discs

- Place the disc in the tray, label side up.
- Make sure the disc tray is fully open when inserting the disc.
- Place the discs flat, 12 cm discs in the outer tray guide (Figure 1), 8 cm discs in the inner tray guide (Figure 2).

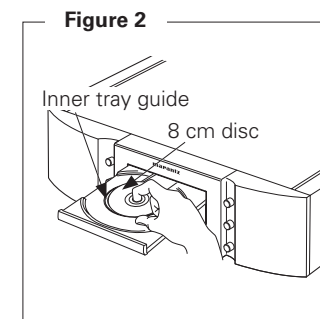
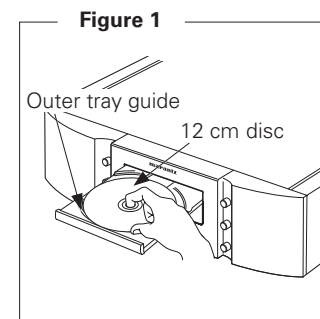

- Place 8 cm discs in the inner tray guide without using an adapter.



- If you place a DVD or other disc that cannot be played by this unit in the disc tray, the tray does not open/close for about 1 minute. When that happens, press **▲** after "0 0:00" is displayed.
- If you place a disc that contains other than MP3 or WMA files, "0 0:00" is displayed.

NOTE

- Do not force the tray in by hand while the power is off. This could cause a trouble.
- Do not insert foreign matter into the disc tray. This could cause a trouble.

Cautions on loading discs

- Only load one disc at a time. Loading two or more discs can damage the unit or scratch the discs.
- Do not use cracked or warped discs or discs that have been repaired with adhesive, etc.
- Do not use discs on which the sticky part of cellophane tape or labels is exposed or on which there are traces of where labels have been removed. Such discs can get caught inside the player and damage it.

Cautions on handling

- Do not get fingerprints, oil or dirt on discs.
- Take special care not to scratch discs when removing them from their cases.
- Do not bend or heat discs.
- Do not enlarge the hole in the center.
- Do not write on the labeled (printed) surface with ball-point pens, pencils, etc., or stick new labels on discs.
- Water droplets may form on discs if they are moved suddenly from a cold place (outdoors for example) to a warm place, but do not try to dry them off using a hairdryer, etc.

Cautions on storing discs

- Be sure to remove discs after using them.
- Be sure to store discs in their cases to protect them from dust, scratches, warping, etc.
- Do not store discs in the following places:
 1. Places exposed to direct sunlight for long periods of time
 2. Dusty or humid places
 3. Places exposed to heat from heaters, etc.

Cleaning discs

- If there are fingerprints or dirt on a disc, wipe them off before using the disc. Fingerprints and dirt can impair sound quality and cause interruptions in playback.
- Use a commercially available disc cleaning set or a soft cloth to clean discs.

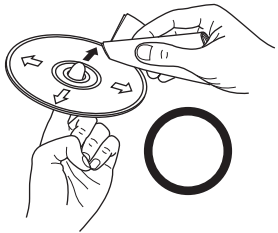

Gently wipe the disc from the inside towards the outside.

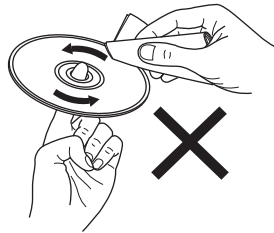

Do not wipe in a circular motion.

NOTE

Do not use record spray, antistatic agents, benzene, thinner or other solvents.

About the remote control

Inserting the batteries

- ① Remove the rear cover of the remote control.
- ② Set two R03/AAA batteries in the battery compartment in the indicated direction.

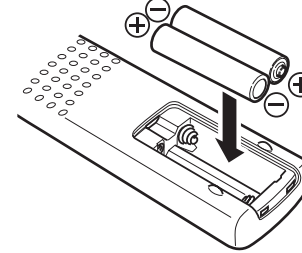
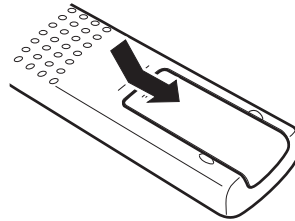

- ③ Put the rear cover back on.

NOTE

- Replace the batteries with new ones if the unit does not operate even when the remote control is operated close to the unit.
- The supplied batteries are only for verifying operation.
- Insert the batteries in the proper direction, following the “+” and “-” marks in the battery compartment.
- To prevent damage or leakage of battery fluid:
 - Do not use a new battery with an old one.
 - Do not use two different types of batteries.
 - Do not attempt to charge dry batteries.
 - Do not short-circuit, disassemble, heat or dispose of batteries in a fire.
- Do not keep the battery in a place exposed to direct sunlight or in places with extremely high temperatures, such as near a heater.
- If the battery fluid leaks, carefully wipe the fluid off the inside of the battery compartment and insert new batteries.
- Remove the batteries from the remote control if it will not be used for a long time.
- Dispose of batteries in accordance with local regulations on battery disposal.
- The remote control unit may function improperly if rechargeable batteries are used.

Operating range of the remote control

Operate the remote control while pointing it at the remote sensor.

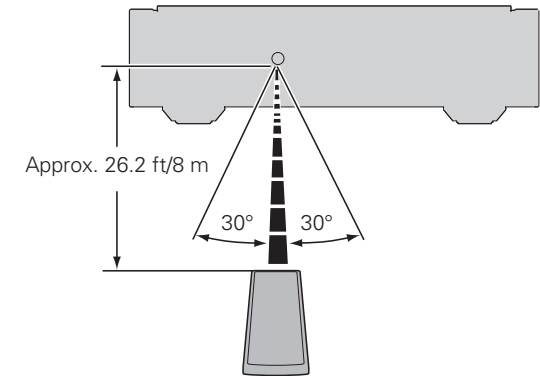

NOTE

- The unit may function improperly or the remote control may not operate if the remote control sensor is exposed to direct sunlight or strong artificial light from a fluorescent or infrared light.
- When using 3D video devices that transmit radio communication signals (such as infrared signals etc) between the various units (such as the monitor, 3D glasses, 3D transmitter unit etc), the remote control unit may not operate due to interference from those radio communication signals. If this occurs, adjust the direction and distance of the 3D communication for each unit, and check that the remote control unit operation is not affected by these signals.

Part names and functions

For buttons not explained here, see the page indicated in parentheses ().

Front panel

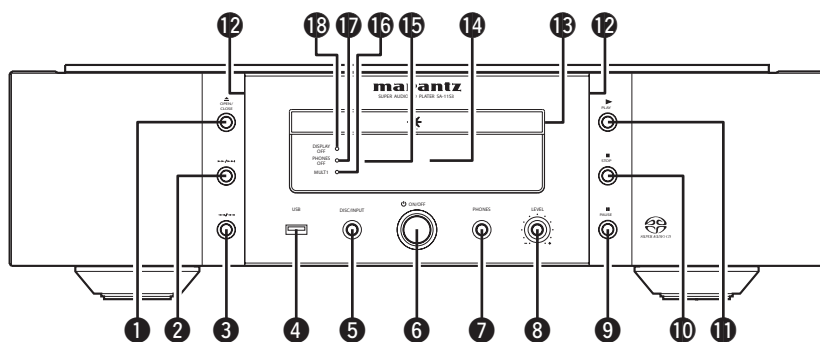

- ① Disc tray open/close button (▲OPEN/CLOSE) (13)
- ② Fast forwarding/Forward-skip button (▶▶/▶▶I) (13)
- ③ Fast reversing/Reverse-skip button (I◀◀/◀◀) (13)
- ④ USB port (USB) (10)
- ⑤ DISC/INPUT button (12)
- ⑥ Power operation switch (⏻ON/OFF)..... (12)
- ⑦ Headphones jack (PHONES) (14)
- ⑧ Headphone volume control knob (LEVEL)..... (14)
- ⑨ Pause button (II) (13)
- ⑩ Stop button (■)..... (13)
- ⑪ Play button (▶) (13)
- ⑫ Illumination lamp (14)
- ⑬ Disc tray (13)
- ⑭ Display (5)
- ⑮ Remote control sensor (4)
- ⑯ Multi Layer indicator (MULTI) (12)
- ⑰ Headphones out off indicator (PHONES OFF)..... (14)
- ⑱ DISPLAY OFF indicator..... (14)

Display

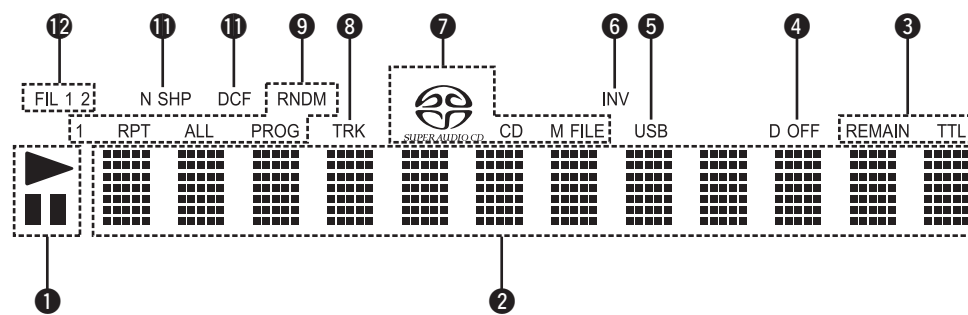

- ① Play mode indicator
II : This indicator lights up during pause.
▶ : This indicator lights up during disc play.
- ② Main display area
This area displays the time display and text information of the disc to be played, as well as the setting menu items, etc.
- ③ Time mode indicator
REMAIN : This indicator lights up while the remaining track time is displayed
TTL : This indicator lights up while the total remaining time or total program time is displayed
- ④ D OFF indicator
This indicator lights up when the digital output setting of the audio CD signal is set to OFF (ⓘ page 24).
- ⑤ USB indicator
This indicator lights up during operation in the USB mode.
- ⑥ INV indicator
This indicator lights up when the inverted phase output setting is in effect (ⓘ page 24 "Phase (analog output phase switching)").
- ⑦ Disc indicator
This indicator displays the disc type which is currently in the disc tray.
"M FILE" lights up if the disc contains WMA/MP3 files.
- ⑧ TRK indicator
This indicator lights up above the display of the track number currently being played.
- ⑨ Special play mode indicator
1 : This indicator lights up during repeat play of one track.
RPT : This indicator lights up during repeat play.
ALL : This indicator lights up during repeat play of all tracks.
RNDM : This indicator lights up during random play.
PROG : This indicator lights up during program play.
- ⑩ DCF indicator
This indicator lights up when the DC filter function is on (ⓘ page 21 "DC filter function").
- ⑪ N SHP indicator
This indicator lights up when the noise shaper function is on (ⓘ page 21 "Noise shaper function").
- ⑫ FIL 1 2 indicator
This indicator shows which filter (Filter 1 or Filter 2) is selected (ⓘ page 21 "Switching the filter characteristics").

Rear panel

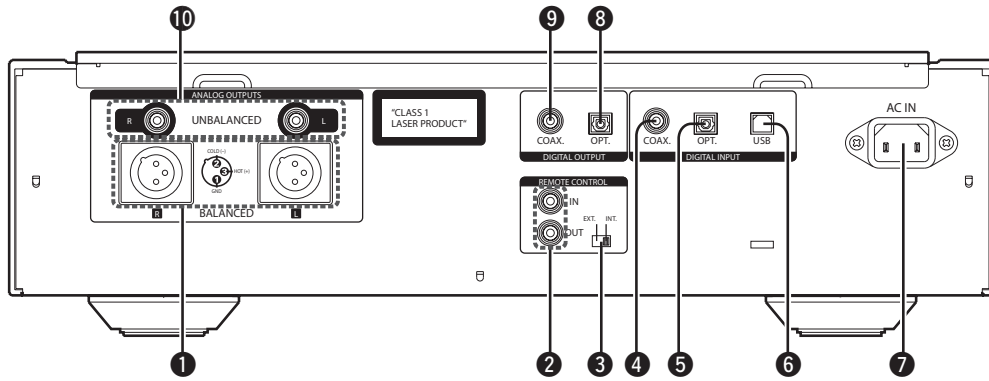

- | | |
|---------------------------------------------------------------------------------------------------------------------------------------------------------------------------------------------------------------------------------------------------------------------------------------------------------------------------------------------------------------------------|--------------------------------------------------------------------------------------------------------------------------------------------------------------------------------------------------------------------------------------------------------------------------------------------------------------------------------------------------------------------------------|
| <p>1 ANALOG OUT BALANCED connectors (ANALOG OUTPUTS BALANCED) (9)</p> <p>2 REMOTE CONTROL IN / OUT connectors (11)</p> <p>3 EXTERNAL/INTERNAL switch (EXT./INT.) (11)</p> <p>4 DIGITAL IN COAXIAL connector (DIGITAL INPUT COAX.) (9)</p> <p>5 DIGITAL IN OPTICAL connector (DIGITAL INPUT OPT.) (9)</p> | <p>6 DIGITAL IN USB port (DIGITAL INPUT USB) (11)</p> <p>7 AC inlet (AC IN) (11)</p> <p>8 DIGITAL OUT OPTICAL connector (DIGITAL OUTPUT OPT.) (9)</p> <p>9 DIGITAL OUT COAXIAL connector (DIGITAL OUTPUT COAX.) (9)</p> <p>10 ANALOG AUDIO UNBALANCED OUTPUT connector (ANALOG OUTPUTS UNBALANCED) (8, 9)</p> |
|---------------------------------------------------------------------------------------------------------------------------------------------------------------------------------------------------------------------------------------------------------------------------------------------------------------------------------------------------------------------------|--------------------------------------------------------------------------------------------------------------------------------------------------------------------------------------------------------------------------------------------------------------------------------------------------------------------------------------------------------------------------------|

Remote control

Buttons for Super Audio CD player

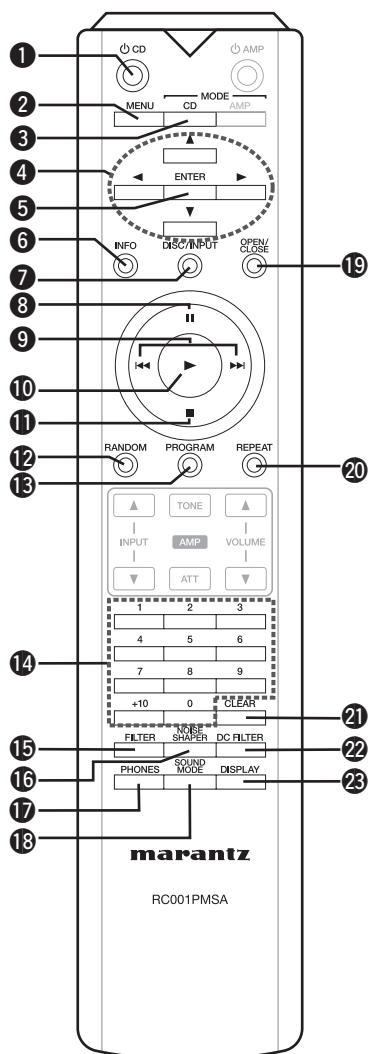

- ❶ Super Audio CD player power button (⏻ CD)..... (12)
- ❷ MENU button (22)
- ❸ Remote control mode switch button (MODE CD)..... (26)
- ❹ Cursor buttons (⏪⏩)..... (22)
- ❺ ENTER button..... (15)
- ❻ Information display switch button (INFO)..... (16)
- ❼ Input selection button (DISC/INPUT)..... (12)
- ❽ Pause button (⏸)..... (13)
- ❾ Skip/Search buttons (⏮⏭)..... (13)
- ❿ Playback button (▶)..... (13)
- ⓫ Stop button (■)..... (13)
- ⓬ RANDOM button..... (15)
- ⓭ PROGRAM button..... (15)
- ⓮ Numeric buttons (0 - 9, +10)..... (13)
- ⓯ FILTER button..... (21)
- ⓰ NOISE SHAPER button..... (21)
- ⓱ PHONES button..... (14)
- ⓲ SOUND MODE button..... (12)
- ⓳ Disc tray open/close button (OPEN/CLOSE)..... (13)
- ⓴ REPEAT button..... (14)
- ⓵ CLEAR button..... (15)
- ⓶ DC FILTER button..... (21)
- ⓷ DISPLAY button..... (14)

Switching remote modes

To operate CD, press **MODE CD** to switch the remote control to the CD operation mode.

Buttons for amplifier

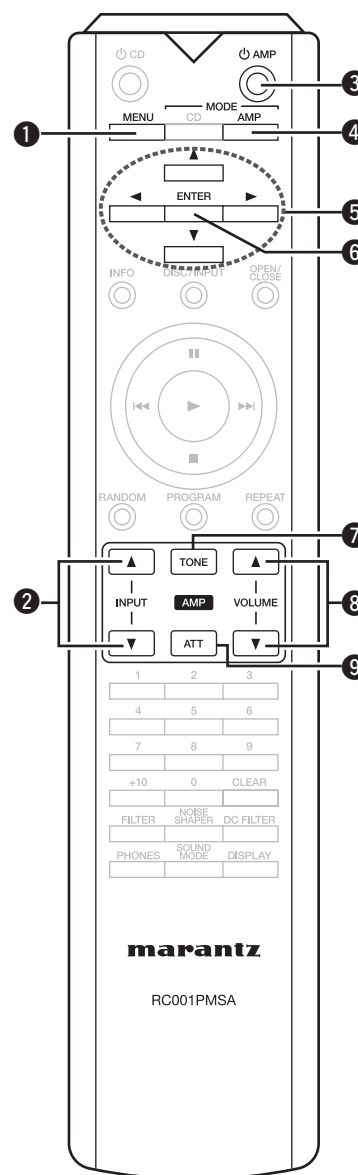

- ❶ MENU button
- ❷ Input selector buttons (INPUT)
- ❸ Amplifier power button (⏻ AMP)
- ❹ Remote control mode switch button (MODE AMP)
- ❺ Cursor buttons (⏪⏩)
- ❻ ENTER button
- ❼ Tone switch button (TONE)
- ❽ Volume buttons (VOLUME ▲▼)
- ❾ Attenuator button (ATT)



- The supplied remote control can operate marantz amplifiers.
- When using it, also refer to the operating instructions of the other devices.

NOTE

The remote control may not operate some devices.

Basic connections

NOTE

- Do not plug in the power cord until all connections have been completed.
- When making connections, also refer to the owner's manual of the other components.
- Insert the plugs securely. Loose connections will result in the generation of noise.
- Be sure to connect the left and right channels properly (left with left, right with right).
- Do not bundle power cords together with connection cables. Doing so can result in humming or noise.
- Do not connect the unit to the PHONO input connectors on the amplifier.

Preparations

Connecting cables

Select the cables according to the equipment being connected.

Audio cables

Analog unbalanced connections (STEREO)

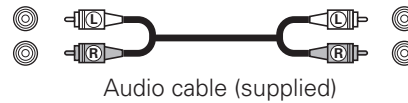

Analog balanced connections

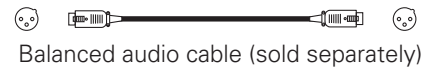

Optical digital connections

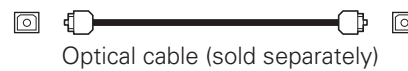

Coaxial digital connections

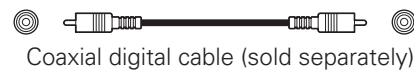

iPod connections

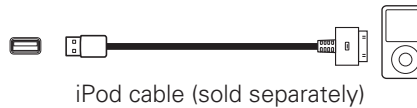

PC connections



Remote control connections



Analog connections (UNBALANCED)

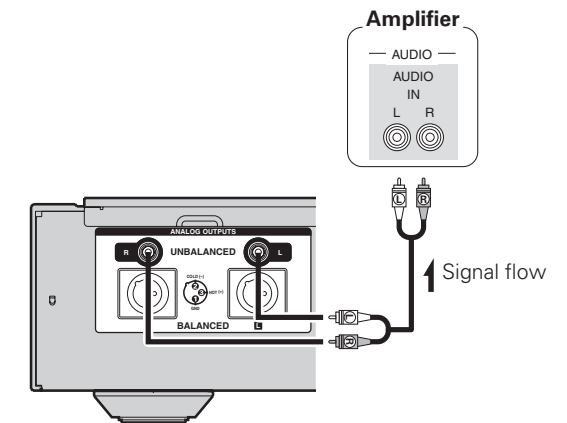

Analog connections (BALANCED)

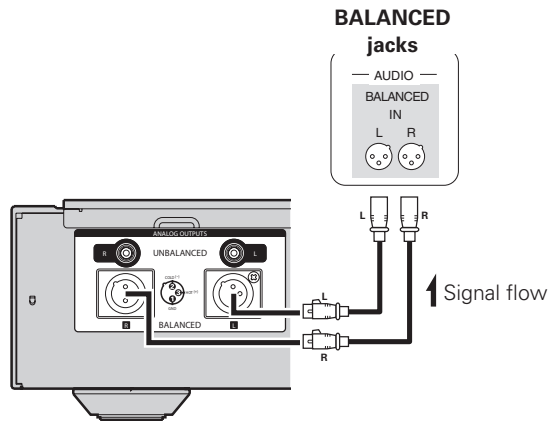

BALANCED Jacks

The BALANCED jacks on this unit are equipped with XLR connectors that are widely used on professional equipment. Their features are listed below.

- The 3 pin construction enables the musical signal to be transmitted as a balanced signal, with little effect from external noise.
- The detachable locking mechanism minimizes connector play and enhances connection reliability.

The XLR connector for professional use is internally wired in either of the following two systems. This unit employs the USA system.

- USA system (② PIN=COLD ③ PIN=HOT)

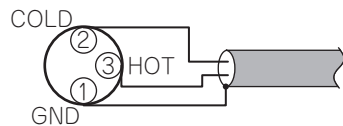

- European system (② PIN=HOT ③ PIN=COLD)

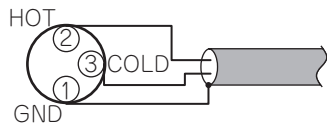

If a product that employs the European system is connected with this unit via a balanced cable, the reproduced signal may be phase-inverted.

To correct the inversion, set the "Phase" to "Inverted" at the menu setting (☞ page 24).

Digital connection

When connecting, use a commercially available optical digital cable or coaxial digital cable.

Digital audio output

Connect digital devices such as AV receivers and D/A converters with the unit to enjoy digital audio output from the unit.

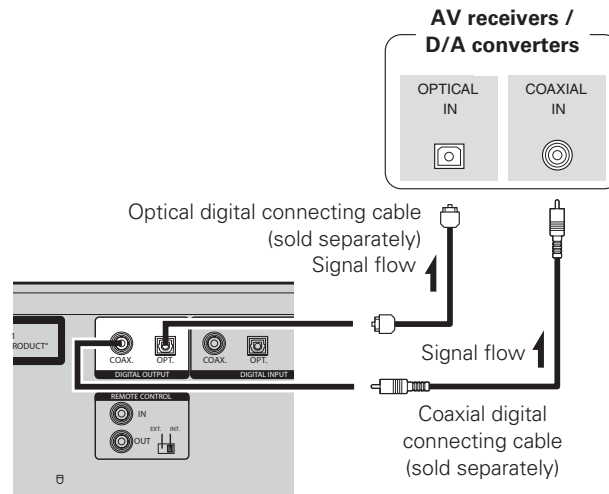

NOTE

Signals on the HD layer of the Super Audio CD cannot be output in digital output. Signals that can be output using digital output are digital audio signals from audio CDs, CD-layers of Super Audio CDs, USB, iPod, PC, COAXIAL, and OPTICAL.

When connecting the optical digital output connector with an optical transmission cable (sold separately)

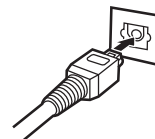

Match the shapes then insert firmly.

Digital audio input

If a device equipped with CD transport or digital audio output is connected to this unit, this unit can be used as a D/A converter ("Using as a D/A converter" (☞ page 20)).

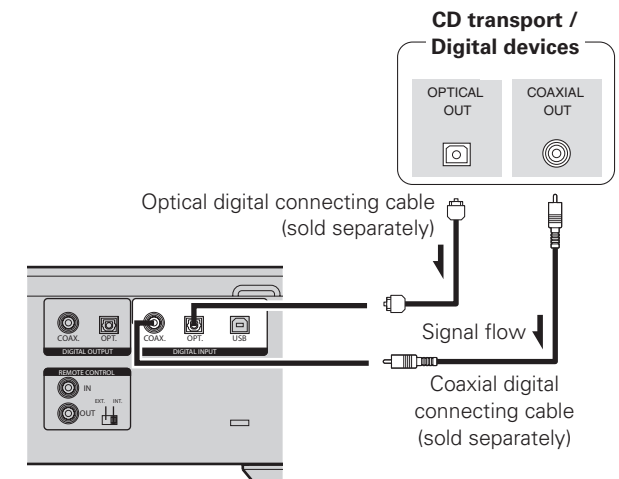

NOTE

- Linear PCM signals with a sampling frequency of 32 kHz, 44.1 kHz, 48 kHz, 64 kHz, 88.2 kHz, 96 kHz, 176.4 kHz, or 192 kHz can be input into this device.
- Do not input signals other than linear PCM signals, such as Dolby digital, DTS, AAC etc. into this device. Doing so may cause noise, which may cause damage to the speakers.

USB memory device / iPod connection

Connect a USB memory device or iPod to the USB port on the front panel of this unit.

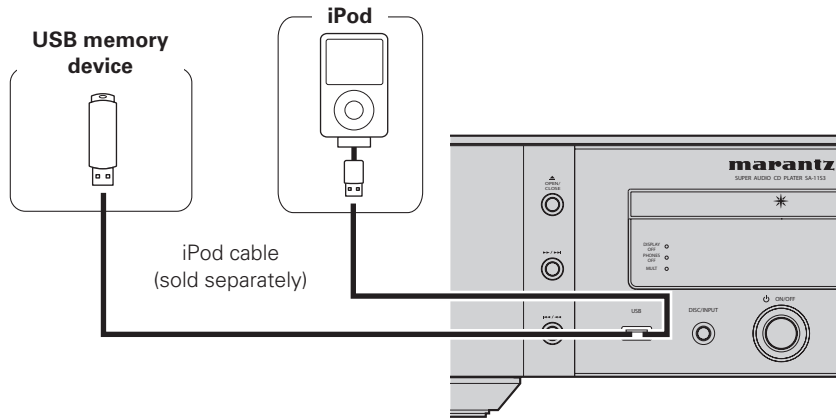

marantz does not guarantee that all USB memory devices will operate or receive power. When using a portable USB connection type HDD of the kind to which an AC adapter can be connected to supply power, use the AC adapter.

NOTE

- Connection to a computer is possible via the digital input USB port on the rear panel. Playback is not possible when connected via the front panel's USB port.
- USB memory devices will not work via a USB hub.
- Do not use an extension cable when connecting a USB memory device. This may cause radio interference with other devices.
- When connecting an iPhone to this unit, keep the iPhone at least 20 cm away from this unit. If the iPhone is kept closer to this unit and a telephone call is received by the iPhone, noise may be output from this device.
- If the iPod is connected using an iPod cable (commercially available) that is longer than 2 m, sound may not be played correctly. In this case, use a genuine iPod cable, or a cable that is shorter than 1 m.
- Files can be read from a USB memory device by connecting the device to this unit. The file reading time varies according to the amount of data saved on the USB memory device. Several minutes may be required to read the maximum permissible number of files and folders.
- Always stop a USB memory device or iPod playback before turning this unit's power off.

Supported iPod / iPhone models

• iPod classic



iPod classic
80GB



iPod classic
160GB (2007)



iPod classic
160GB (2009)

• iPod nano



iPod nano
3rd generation
(video)
4GB 8GB



iPod nano
4th generation (video)
8GB 16GB



iPod nano
5th generation (video camera)
8GB 16GB



iPod nano
6th generation
8GB 16GB

• iPod touch



iPod touch
1st generation
8GB 16GB 32GB



iPod touch
2nd generation
8GB 16GB 32GB



iPod touch
3rd generation
32GB 64GB



iPod touch
4th generation
8GB 32GB 64GB

• iPhone



iPhone
4GB 8GB 16GB



iPhone 3G
8GB 16GB



iPhone 3GS
8GB 16GB 32GB



iPhone 4
8GB 16GB 32GB



iPhone 4S
16GB 32GB 64GB

(as of May 2012)

PC connection

By connecting a computer to the USB port on the rear panel of this unit using a commercially available USB connecting cable, this unit can be used as a D/A converter "Using as a D/A converter" (page 20).

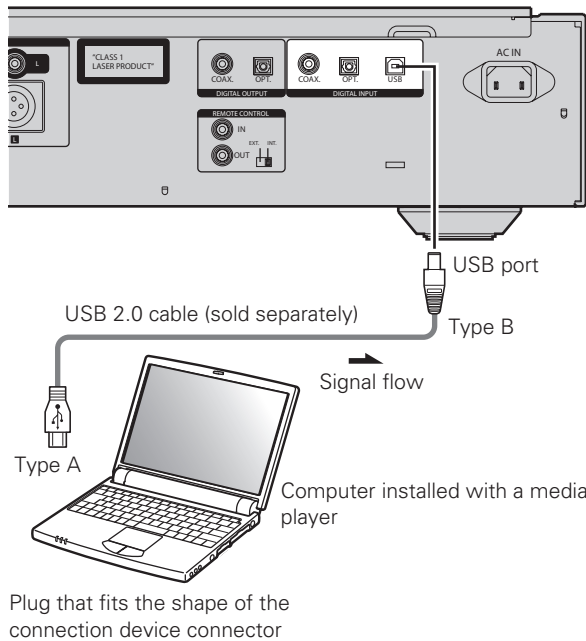

Remote control connection

When you use this unit connected to a marantz amplifier, this unit receives operation signals sent from the amplifier and operates accordingly.

Connection

Use the supplied remote connection cable to connect the REMOTE CONTROL IN terminal of this unit to REMOTE CONTROL OUT terminal of the amplifier.

Setting

Set the remote control switch on the rear panel of this unit to "EXT." to use this feature.

- This setting will disable remote sensor reception of this unit.
- To operate the unit, point the remote control at the remote sensor of the amplifier.



To use this unit without connecting it to the amplifier, set the remote control switch to "INT.".

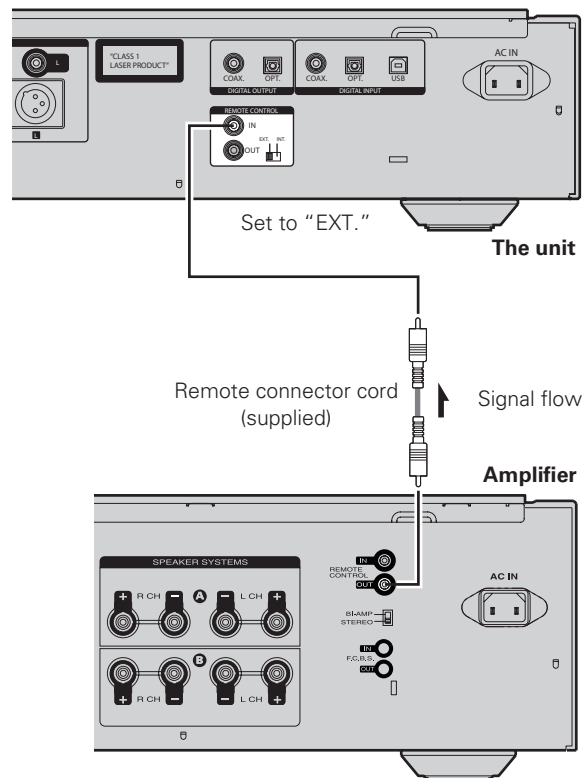

Connecting the power cord

Do not plug in the power cord until all connections have been completed.

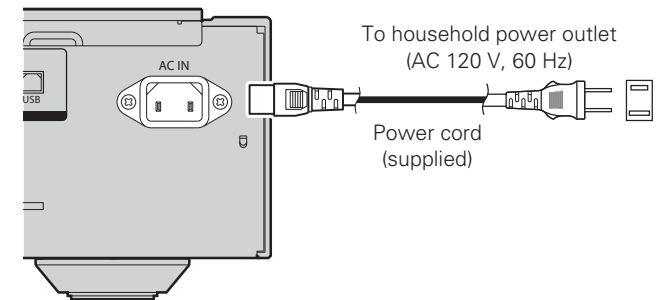

NOTE

- Insert the plugs securely. Loose connections will result in the generation of noise.
- Do not unplug the power cord while the unit is operating.
- Do not use a power cord other than the cord supplied with this unit.

Operation

Before use

Power ON

Press **ON/OFF**, on the unit.
A power on status is established.

Switching to a standby status

Press **CD**.
A standby status is then established.

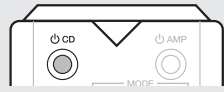

Before setting power to standby, make sure the disc tray is completely closed.

NOTE

- Do not force the tray in by hand while power is set to standby. This could cause a trouble.
- Even when power is set to standby, electrical current passes through some circuits. If you do not intend to use the unit for an extended period of time, unplug the power cord from the household power outlet.

Turning the power off

Press **ON/OFF** on the unit.
The power turns off.

Switching the input source

This unit supports the following playback functions in addition to disc playback.

- Digital audio input signal playback
 - USB memory device file playback from the USB port in the front panel
 - iPod file playback from the USB port in the front panel
 - Computer file playback from the USB port in the rear panel
- Before playing back files from a connected device, perform the following operation to switch the input source.

Press **DISC/INPUT** to select the input source.

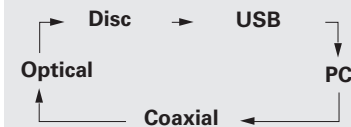

[Selectable modes]

- Disc** : Plays back the disc inside the disc tray (page 13).
- USB** : Plays back files on the device connected to the USB port (USB) on the front panel (page 17, 18).
- PC** : Connect a computer to the USB port (DIGITAL IN) on the rear panel, and use this unit as a D/A converter (page 20).
- Coaxial** : Connect a digital device to the COAX. connector (DIGITAL IN) on the rear panel, and use this unit as a D/A converter (page 20).
- Optical** : Connect a digital device to the OPT. connector (DIGITAL IN) on the rear panel, and use this unit as a D/A converter (page 20).

Switching the sound mode (Playback layer)

Some Super Audio CD discs have 2 layers. Before playback, perform the operation below to select the playback layer. For details on the Super Audio CD, see "Super Audio CD" (page 25).

- Press **DISC/INPUT** to set the playback media mode to "Disc".
- Insert a disc.
Press **OPEN/CLOSE** to open and close the disc tray.
- Press **SOUND MODE** and switch to the layer you want to set.

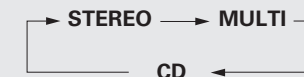

[Selectable items]

- STEREO** : Plays back the 2-channel area of the Super Audio CD (the default setting).
- MULTI** : Plays back the multi-channel area of the Super Audio CD. Multi-channel is downmixed to 2-channel.
- CD** : Plays back the CD layer of the Super Audio CD.

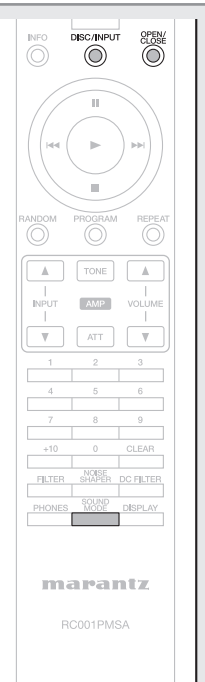

Before use

Setting the playback sound mode in advance (Start sound mode)

When purchased, the sound mode setting is "STEREO". The procedure for specifying a different first-priority layer is given below.

With no disc in the disc tray, press **SOUND MODE**, then switch to the desired layer setting.

- If a disc that does not contain the layer set for top priority playback is loaded, the contents recorded on another layer are displayed automatically.

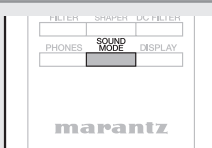

- This unit memorizes the setting. Even if you open/close the disc tray or turn this unit off and on, the setting remains in effect.
- The layer detection order is as follows for discs without an area set for the first-priority layer or discs without any layer.
① STEREO ② MULTI ③ CD

Playback CDs

Playing Super Audio CDs or CDs

1 Press **DISC/INPUT** to change the input source to "Disc".

2 Insert a disc.

- Press **OPEN/CLOSE** to open and close the disc tray.
- You can also close the disc tray by pressing **▶**, then starts playback automatically.

3 When playing back a Super Audio CD, press **SOUND MODE**, and select the layer that you want to play back.

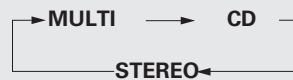

4 Press **▶**

The **▶** display lights, and playback begins.

- When all of the tracks recorded on the disc have finished playing back, playback stops automatically.



Stopping Playback

Press **■**.

Stopping Playback temporarily

Press **||**.

- The **||** indicator lights.
- To restart playback, press **▶**.

Fast-Forwarding and Fast-Reversing (Searching)

The search is started by holding down **⏮**, **⏭** during playback.

Normal playback resumes when the button is released.

Moving to the Beginning of Tracks (Skipping)

During playback, press **⏮** or **⏭**.

- The disc is skipped the number of tracks equal to the number of times the button is pressed.
- When you press **⏮** once, playback restarts from the beginning of the current track.

Playing a Specific Track (Direct searching)

Press NUMBER (**0 – 9, +10**) to select the track.

Example: Track 4 : **4**

Example: Track 12 : **+10, 2**

Example: Track 20 : **+10, +10, 0**

Having the display and the illumination lamp off

The display circuit operation can be stopped to minimize noise from the display and the display circuit which could interfere with the analog audio output signal.

During playback, press **DISPLAY**.

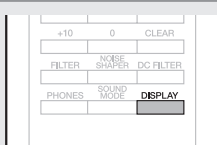

- Each time you press **DISPLAY**, the LCD display and the illumination lamp (blue) switch ON/OFF at the same time.



- When the display is switched off, the "DISPLAY OFF" indicator lights.
- If you press the **DISPLAY** at any time other than during playback, the LCD display and the illumination lamp (blue) do not light off.

NOTE

During stop mode, the display information does not turn off. The information is turned off only during playback.

Having the illumination lamp always off

The following procedure makes the illumination lamp always off regardless of the display ON/OFF operation.

Press and hold **DISPLAY** for two seconds and longer while playback is stopped.

- Press and hold **DISPLAY** for two seconds and longer while the lamp is always off to return to the normal setting.

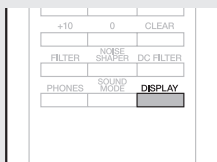

Display switching

Displays text and time information stored on media.

- The display content varies according to the media. (The text information is only displayed for SACD.)
- The display content during playback and when stopped varies according to the media.
- Text information displays in a scroll format.
- Characters that can be displayed are uppercase/lowercase alphabets, numbers, and some symbols.

Press **INFO** button.

The display switches each time the button is pressed.



[When stopped]

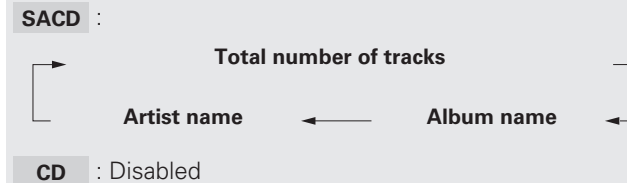

[During playback (pause)]

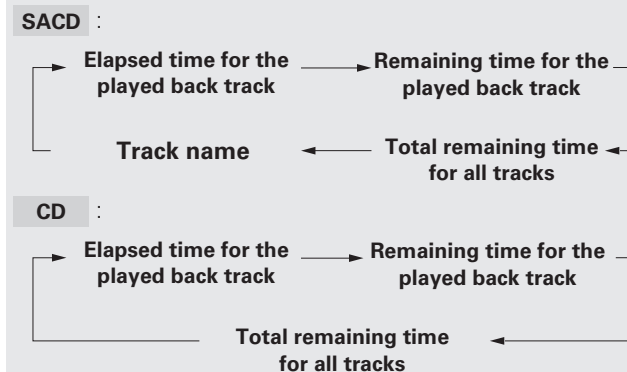

Listening with headphone

Plug the headphones into the headphone jack (**PHONES**).

Adjusting the Volume

Turn **LEVEL**.

NOTE

To prevent hearing loss, do not raise the volume level excessively when using headphones.

Stopping the headphones output

The headphones circuit operation can be stopped to minimize noise from the headphones circuit which could interfere with the analog audio output signal.

Press **PHONES**.

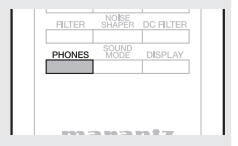
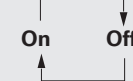

- The headphones off indication lights when the headphones circuit is stopped.

Playing repeatedly (Repeat Playback)

Press **REPEAT** to select repeat mode.

- When **REPEAT** is pressed each time, the display switches repeat modes in the following order.

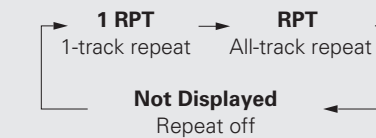

[Selectable items]

RPT (All-track repeat) : All tracks are played repeatedly.

1 RPT (1-track repeat) : Only 1 track is played repeatedly.

Not Displayed (Repeat off) : Normal playback resumes.

Playing in random order (Random playback)

- 1 During stop mode, press **RANDOM**.
The "RNDM" indicator on the display lights.
- 2 Press **▶**.
The tracks start playing in random order.



❑ Stopping Random Playback

Press **RANDOM** during stop mode.
The "RNDM" indicator on the display goes off.

NOTE

- Each press of **▶▶** during random play changes the track in random manner.
- The random playback mode is canceled if you set power to standby, turn off power, or open the disc tray.

Playing tracks in a specific order (Program playback)

- 1 During stop mode, press **PROGRAM**.
"PROG" lights in the display, and the mode switches to program playback mode.
- 2 Use **NUMBER (0 – 9, +10)** to select the tracks you want to program.

[Example]

To program tracks 3 and 12 to be played in that order, press **3**, **+10**, and **2** one after the other.

- 3 Press **▶**.
Playback starts in the programmed order.



❑ Adding tracks for program playback

Tracks can be added to the end of program when program is remaining ("PROG" indicator is lighting up) and in stop mode.

Use **NUMBER (0 – 9, +10)** to select the tracks you want to program.

❑ Checking programmed track orders

While stopped, press **▶▶**.
Each time you press it, tracks are displayed in the order in which they are programmed.

❑ Canceling a track from program playback

While stopped, press **CLEAR**.
When **CLEAR** is pressed, tracks are deleted in order from the last programmed track.

❑ Clearing the all programmed track

Press **PROGRAM** during stop mode.
• Program can also be cleared by pressing **OPEN/CLOSE** to open the disc tray.



You can specify up to 20 tracks each for program playback.

NOTE

- Programmed playback is not possible with MP3 and WMA files.
- The program playback mode is canceled if you set power to standby, turn off power, or open the disc tray.

Stopping digital outputs

Stops all media and source digital signal outputs from the rear panel's digital audio output connectors (COAX., OPT.) to minimize digital audio output circuit noise which could interfere with the analog audio output signal.

- 1 During stop mode, press **MENU**.
- 2 Use **Δ∇** to select "Digital Out", and press **ENTER**.
- 3 Use **Δ∇** to select "Off", and press **ENTER**.

[Selectable items]

- On** : Outputs the digital signal.
- Off** : Digital signal is not output.

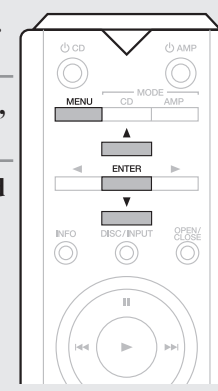

- When digital output is turned off, the "D OFF" indicator lights up on the display.
- The "digital output off" has a memory retention function where the settings remain stored and unchanged even when the disc is changed or the power is turned off.

NOTE

This unit does not output Super Audio CD multi-channel layer and stereo layer digital audio signals from the digital audio output connectors.

Playback of MP3 and WMA files

There are many music distribution sites on the Internet allowing you to download music files in MP3 or WMA (Windows Media® Audio) formats. The music (files) downloaded from such sites can be stored on CD-R or CD-RW discs and played on the unit.

“Windows Media” and “Windows” are registered trademarks or trademarks of Microsoft Corporation in the United States and other countries.

MP3 and WMA formats

CD-R and CD-RW discs created in the format described below can be played.

❑ Writing software format

ISO9660 level 1, 2

Expansion format (Juliet.Romeo)

- When written in other formats, it may not be possible to play the disc properly.

❑ Maximum number of playable files and folders

Total number of folders and files: 1000

Number of folders: 255

❑ File formats

MP3 (MPEG-1 Audio Layer-3)

WMA (Windows Media Audio)

Playable MP3/WMA file			
File format	Sampling frequency	Bit rate	Extension
MP3	44.1kHz	MPEG-1 Audio Layer-3, 32/40/48/56/64/80/96/112/128/160/192/224/256/320 kbps	.mp3
WMA	44.1kHz	48/64/80/96/128/160/192 kbps	.wma



- Only music files that are not copyright-protected can be played on this unit.
- Be sure to give files the extension “.mp3” or “.wma”. Files with any other extensions or with no extensions cannot be played.
- In accordance with copyright laws, recordings you have made should only be used for your personal enjoyment and may not be used in other ways without permission of the copyright holder.

MP3 and WMA file playback

1 Load the CD-R / CD-RW containing MP3 or WMA type audio files to the disc tray. (☞ page 13)

2 At the menu’s “Play File” item (☞ page 23), select the folder or All.

3 Press ▶. Playback starts.

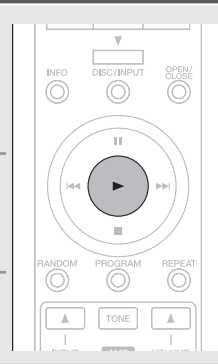

❑ Changing the playback folder

Use Δ∇ to select the desired folder.

❑ Changing the playback file

Use ◀▶ to select the desired file.

❑ Switching the display

During playback, press **INFO**.

Text information then displays in a scroll format.

❑ Playing back MP3 and WMA files randomly (random playback)

While stopped, press **RANDOM**.

- During random playback, the playback range becomes “All”.

❑ Playing back MP3 and WMA files repeatedly (folder/disc repeat playback)

Press **REPEAT**.



- Folder and file names can be displayed as titles. Up to 11 alphanumeric characters and underscores can be displayed. Characters which cannot be displayed appear as asterisks.
- The following characters can be displayed.

A - Z a - z 0 - 9

! " # \$ % & ; : < > ? @ \ [] _ ` { } ~ ^ ' () * + , - . / = (Blank)

MP3 or WMA playback order of MP3 or WMA files

When there are multiple folders containing MP3 or WMA files, the playback order of folders is automatically set when this unit reads the media.

❑ Playback order of folders

CD-R/CD-RW

For playback of files on CD-R or CD-RW, files in all folders on the first layer are played first, next on the second layer, then next on the third layer, and so on in this order.

The files in each folder are played back in the order in which the files were recorded on the media, from the oldest date and time.

USB memory device

For playback of files recorded on USB memory device, files in the first folder on the first layer are played first, next folders on the second layer in the folder, then next on the third layer, and so on in this order. Then accordingly files on another first layer are played.

The files in each folder is played in the file name order.



- The playback order displayed on a PC may differ from the actual playback order.
- The playback order with a CD-R/CD-RW may differ, depending on the writing software.

NOTE

The playback order may differ from the order in which the folders or files were recorded if you delete or add a folder or file on USB memory device. This occurs because of data recording specifications and is not a malfunction.

Playback iPod®

With the unit, you can listen to music on an iPod and you can also operate the iPod with the main unit or the remote control.



“Made for iPod” and “Made for iPhone” mean that an electronic accessory has been designed to connect specifically to iPod or iPhone, respectively, and has been certified by the developer to meet Apple performance standards. Apple is not responsible for the operation of this device or its compliance with safety and regulatory standards.

iPhone, iPod, iPod classic, iPod nano, iPod shuffle, and iPod touch are trademarks of Apple Inc., registered in the U.S. and other countries.

- Individual users are permitted to use iPhone, iPod, iPod classic, iPod nano, iPod shuffle, and iPod touch for private copy and playback of non-copyrighted contents and contents whose copy and playback is permitted by law. Copyright infringement is prohibited by law.

Playing an iPod®

- Press **DISC/INPUT** to change the input source to “USB”.



- Connect the iPod to the USB terminal on the front panel of this unit (see page 10).

Select the mode to control

- Press **MENU** during stop mode.

- Use Δ/∇ to select “iPod Ctrl”, and press **ENTER**.

- Use Δ/∇ to select the mode to operate, and press **ENTER**.

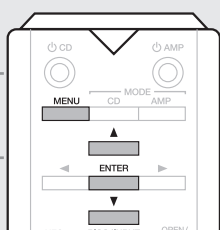

[Selectable items]

Direct : Control using the iPod.

Remote : Control using this unit and the remote control.

Display mode		Direct	Remote
Display location		iPod display	Main unit display
Playable files	Audio file	○	○
	Video file	○	×
Active buttons	Remote control and Main unit (This unit)	○	○
	iPod	○	×

Select the file to playback

Press Δ/∇ to select an item and press **ENTER** or \triangleright to select a music file you want to play back.

Starts the playback of selected file.

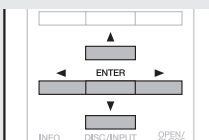

Remote control and iPod button relations

Remote control buttons	iPod buttons	Operation on the unit
\blacktriangleright	$\blacktriangleright\parallel$	Plays the track
\parallel	$\blacktriangleright\parallel$	Pauses the track
\blacksquare	—	Stops the track
\lll, \ggg	\lll, \ggg	Skip to previous or next track.
REPEAT	—	Switches the repeat function
RANDOM	—	Switches the shuffle function
INFO	—	Switches the display (Remote mode)
\lll, \ggg (Press and hold)	\lll, \ggg (Press and hold)	Manual search (fast-reversing, fast-forwarding)
Δ/∇	Click Wheel	Moves up/down the cursor
\triangleleft	Menu	Calls the menu/returns from the menu
\triangleright or ENTER	Select	Confirm the settings/playback

NOTE

- marantz will accept no responsibility whatsoever for any loss of iPod data.
- Depending on the type of iPod and the software version, some functions may not operate.

To Switch the Display

During playback, press **INFO**.

The display switches each time the button is pressed.



Disconnecting the iPod

- Press \blacksquare .
- Disconnect the iPod cable from the USB port.

Playing a USB memory device

Playable USB memory formats

Files created in the following formats and stored on a USB memory device can be played.

❑ USB-Compatible file systems

FAT16 or FAT32

- If the USB memory device is divided into multiple partitions, only the top drive can be selected.

❑ Maximum number of playable files and folders

This depends on the specification of the USB memory device (FAT16 or FAT32).

❑ File format

MP3 (MPEG-1 Audio Layer-3)
WMA (Windows Media Audio)
AAC (Advanced Audio Codec)
WAV (Linear PCM)

❑ Tag data

ID3-TAG (Ver.1.x and 2.x)
WMA-TAG
AAC-TAG

The title, artist, and album tag data are supported.

Playable MP3/WMA file			
File format	Sampling frequency	Bit rate	Extension
MP3	32, 44.1, 48 kHz	MPEG-1 Audio Layer-3, 32/40/48/56/64/80/96/112/128/160/192/224/256/320 kbps	.mp3
WMA	32, 44.1, 48 kHz	CBR: 48 – 320 VBR: Peak 384 (display corresponds to average bit rate value)	.wma
AAC	32, 44.1, 48 kHz	8 – 320 kbps	.m4a
LINEAR PCM	Linear PCM: PCM 32/44.1/48 Those other than the above, not supported.	Linear PCM: 16 bit	.wav



- Only music files that are not copyright-protected can be played on this set.
- Contents downloaded from pay sites on the Internet are copyright protected. Also, files encoded in WMA format when ripped from a CD, etc., on a computer may be copyright protected, depending on the computer's settings.

Playing files stored on USB memory devices

1 Press **DISC/INPUT** to change the input source to “USB”.

2 Connect the USB memory device to the USB terminal on the front panel of this unit. (☞ page 10)

3 Press Δ / ∇ to select a file/folder you want to play back and press **ENTER**, \triangleright or \triangleleft .

4 Press Δ / ∇ to select a file and press **ENTER**, \triangleright or \triangleleft . Playback starts.

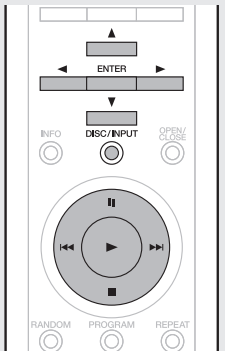

❑ To switch file during playback

• File

Use **I◀◀** or **▶▶I** to select the file.

Remote control buttons	Operation on the unit
▶	During playback
 	Pause
■	When stopped
△▽	Moves up/down the cursor
◀	Calls the menu/returns from the menu
I◀◀, ▶▶I (Press and hold)	Manual search (fast-reversing, fast-forwarding)
REPEAT	Switches the repeat function
RANDOM	Switches the random function
INFO	Switches the display
ENTER or ▷	Confirm the settings/playback



- When the menu's "USB Resume" (page 24) is on, playback starts automatically when a USB memory device is connected.
- When a USB memory device is connected to this unit, playback starts automatically when "USB" input source switching occurs.

❑ Stopping Playback

Press **■**.

❑ Stopping Playback temporarily

Press **||**.

- The **||** indicator lights.
- To restart playback, press **▶**.

❑ Fast-Forwarding and Fast-Reversing (Searching)

Press and hold **I◀◀** or **▶▶I** during playback.

- When you remove your finger from the button, normal playback is resumed.
- When normal playback is resumed after searching, the sound may be interrupted momentarily.

❑ Playing repeatedly (Repeat playback)

Press **REPEAT**.

❑ Playing in random order (Random playback)

Press **RANDOM**.

- To cancel random playback, press **RANDOM**. The "RNDM" indicator goes dark and random playback is canceled.
- During random playback of files stored on a USB memory, each time a track is over, another track is randomly selected for playback from all tracks within the playback range.

Therefore, an identical track may be played back twice in a row.

❑ Switching the Display

During playback, press **INFO**.

NOTE

- marantz will take no responsibility whatsoever for any loss or damage to data on a USB memory device when using it connected to the unit.
- USB memory devices will not work via a USB hub.
- marantz does not guarantee that all USB memory devices will operate or be supplied power. When using a USB portable hard disk that can draw power from an AC adapter, we recommend using the AC adapter.

Removing the USB memory device

1 Press **■** to stop playback.

2 Check that the communication indicator on the USB memory device is not flashing, then pull out the USB memory device.

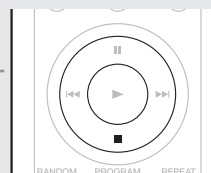

NOTE

Do not pull out the USB memory device if the communication indicator on the USB memory device is still flashing. Doing so may damage the USB memory device and the data recorded on the device.

Using as a D/A converter

Digital audio signals input from an external device or computer into this unit can be converted and output as analog signals using this unit (D/A converter).

Connect and playback from a digital device (Coaxial/Optical)

Press **DISC/INPUT** to change the input source to “Coaxial” or “Optical”.

The input digital audio signal is displayed as shown.

“Coax : xxxx”

“Opt : xxxx”

xxxx indicates the sampling frequency.

- If the sampling frequency cannot be detected, “Unlock” will be displayed.

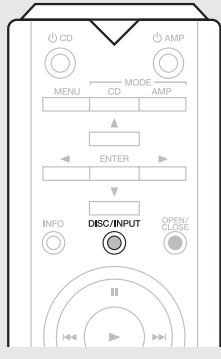

NOTE

- Linear PCM signals with sampling frequencies of 32 kHz, 44.1 kHz, 48 kHz, 64 kHz, 88.2 kHz, 96 kHz, 176.4 kHz and 192 kHz can be input in the unit.
- Do not input non-PCM signals, such as Dolby Digital, and DTS. This causes noise and could damage the speakers.
- If the sampling frequency switches, such as from A mode to B mode in a CS broadcast, muting may operate for 1-2 seconds, cutting the sound.

□ When the mode has been changed to disc playback mode

Press **DISC/INPUT** and switch the input source to “Disc”.

Connecting and playing back from a computer (USB)

□ Installing the dedicated driver

Before music files saved on a computer can be played on this unit, the dedicated driver must be downloaded from the marantz website, and installed in the computer.

NOTE

- The dedicated driver must be installed in the computer before this unit is connected to a computer. Operation will not occur correctly if connected to the computer before the dedicated driver has been installed. Moreover, if the computer is running Windows XP as its OS, the computer's speed will decrease significantly, and a computer restart may be required.
- Operation may fail in some computer hardware and software configurations.

□ Connection

Use the rear panel USB port to connect this unit to a personal computer. For the connection procedure, refer to the “PC connection” section (page 11).

Press **DISC/INPUT** to change the input source to “PC”.

When “PC : xxxx” is displayed on this unit, wait for approximately 10 seconds, and then start and operate the music playback software on the computer. This unit functions as a D/A converter.

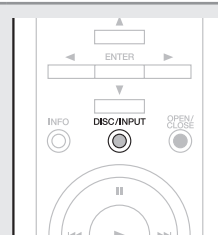

NOTE

- Perform operations such as playback and pause on the computer. At this time, you cannot perform operations with buttons on this unit or the remote control.
- You can also control the volume and equalizer on the computer. Enjoy playing music at the desired volume.
- When this unit is functioning as a D/A converter, sound is not output from the computer's speakers.
- If the computer is disconnected from this unit while the computer music playback software is running, the playback software may freeze. Always exit the playback software before disconnecting the computer.
- When an abnormality occurs on the computer, disconnect the USB cable and restart the computer.
- The supported sampling frequencies are 32/44.1/48/88.2/96/176.4/192 kHz.
- The sampling frequency of the music playback software and sampling frequency displayed on this unit may differ.

□ Computer (recommended system)

OS

- Windows® XP Service Pack3, Windows® Vista or Windows 7
- Macintosh OSX 10.6.3 or later.

Software

- Server software supporting Windows Media Player® and iTunes.

USB

- USB 2.0: USB High speed/USB Audio Class V2.0

Specifying the desired sound quality

This unit is equipped with a sound quality adjusting function which allows users to enjoy the desired playback sound quality.

- This setting remains effective even if the power is turned off.

Noise shaper function

Digital feedback is used to improve the low-sound linearity and the noise characteristics of the audible band.

Although no difference is observed in the measured values, the sound quality is changed, allowing users to specify a favorite sound quality.

Press NOISE SHAPER.

- The setting switches between on and off each time the button is pressed.
- When on, the "N SHP" indication lights on the display.

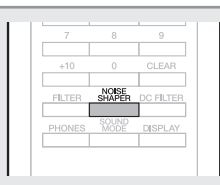

NOTE

The noise shaper function is disabled during playback of a 32 kHz sampling frequency source.

DC filter function

This filter is effective in preventing excessive speaker vibration when playing discs where audio with extremely low noise characteristics has been recorded. (The cut frequency is set at 1.7 Hz.)

Press DC FILTER.

- The setting switches between on and off each time the button is pressed.
- When on, the "DCF" indication lights on the display.

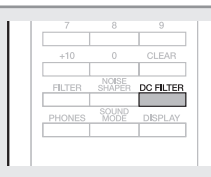

NOTE

The DC filter function is disabled during playback of a 32 kHz sampling frequency source.

Switching the filter characteristics

2 filter characteristic types can be selected for Super Audio CD playback, and for audio CD playback. The 2 filter characteristics types are explained below.

Filter Type	Audio CD	Super Audio CD
FIL 1	Offers a short impulse response for both pre-echo and post-echo. Suitable for large-information-content audio. Produces a deep sound image with clearly-defined positional relationships of the audio sources.	This is a direct mode in which there is no filtering versus the DSD data (Super Audio CD recording signal). The original source data is reproduced as it is, along with the original texture and space.
FIL 2	This filter offers asymmetrical impulse response. The post-echo is slightly longer than the pre-echo. Resembles analog sound quality.	DSD data exceeding 100 kHz is attenuated. Also equipped with DACs for normal-phase and inverted-phase signals (23 each). The asymmetrical DAC operation gives priority to the resolution, resulting in a smoother sound.

Press FILTER.

- The setting cycles through the 2 modes (FIL 1 / FIL2) and off as shown below each time the button is pressed.

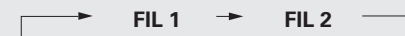
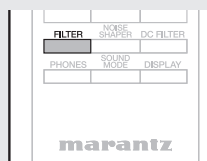

NOTE

The noise shaper, DC filter, and filter characteristics have a last memory function. These settings remain in memory even if a disc change occurs, or if the power is turned off.

Menu settings

You can set the following functions.
For further information, see the page indicated in parentheses ().

1 During stop mode, press **MENU**.

2 Press Δ/∇ to select the menu item you want to set.

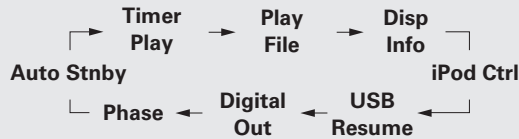
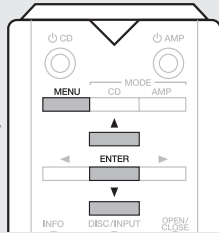

[Selectable modes]

- Timer Play** : Switches the timer playback function On/ Off. (☞ page 22)
- Play File** : Switches a file media playback range ("All" or "Folder"). (☞ page 23)
- Disp Info** : Sets the iPod and USB memory device information that displays during playback. (☞ page 23)
- iPod Ctrl** : Switches the iPod's operation mode. (☞ page 23)
- USB Resume** : Switches the USB memory device resume playback On/Off. (☞ page 24)
- Digital Out** : Switches the digital audio output On/Off. (☞ page 24)
- Phase** : Switches the analog output phase. (☞ page 24)
- Auto Stnby** : Switches the auto standby function On/ Off. (☞ page 24)

3 Press **ENTER**.

NOTE

Menu cannot be set during playback.

Timer Play (Timer play setting)

This unit can perform timer play by cooperating with your audio timer.

1 Insert the media to playback into the unit.

2 Use Δ/∇ to select "Timer Play" and press **ENTER**.

3 Use Δ/∇ to select "On" or "Off" and press **ENTER**.

[Selectable modes]

- Off** :Timer play is not set.
- On** :Timer play is set.

4 Press **MENU**.
Saves the timer play settings.

5 Press **DISC/INPUT** to select the input source for timer playback.

6 Set the audio timer.

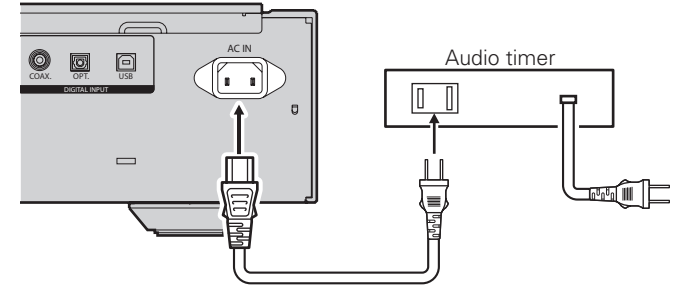
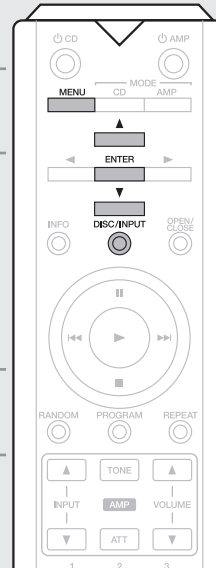

NOTE

For connection to audio timer and it's operation, please refer to the instruction manual of your audio timer.

Play File (Play range setting)

Selects whether “all files” or “files within a specific folder” are to be played during a disc or USB memory device playback.

1 Use Δ / ∇ to select “Play File” and press **ENTER**.

2 Use Δ / ∇ to select “Disc” or “USB” and press **ENTER**.

3 Use Δ / ∇ to select the desired playback range, and press **ENTER**.

[Selectable modes]

All :All files on the Disc or the USB memory are played.

Folder :Files within a selected folder are played.

4 Press **MENU**.
Saves the settings.

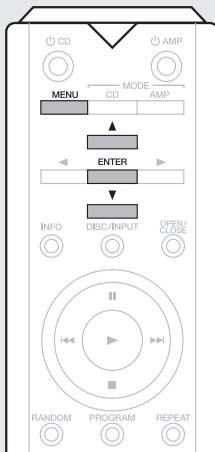

Disp Info (file information display selection)

Specifies the information which is displayed during iPod and USB memory device playback.

1 Use Δ / ∇ to select “Disp Info” and press **ENTER**.

2 Use Δ / ∇ to select “iPod” or “USB” and press **ENTER**.

3 Use Δ / ∇ to select the information you want to display and press **ENTER**.

[Selectable items]

Time :Displays the time information.

File Name :Displays the time information.

Title :Displays the title name.

Artist :Displays the artist name.

Album :Displays the album name.

4 Press **MENU**.
Saves the settings.

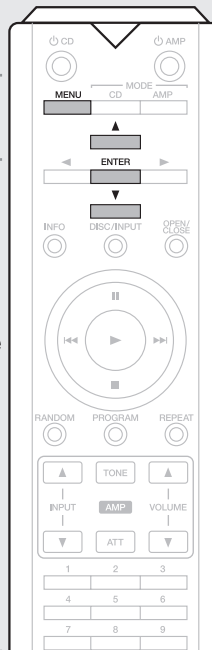

iPod Ctrl (Switch the iPod operation mode)

Specifies whether iPod operation is to be performed from the unit or at the iPod.

1 Use Δ / ∇ to select “iPod Ctrl” and press **ENTER**.

2 Use Δ / ∇ to select the device you want to control and press **ENTER**.

[Selectable modes]

Direct :Control using the iPod.

Remote :Control using this unit and the remote control.

3 Press **MENU**.
Saves the settings.

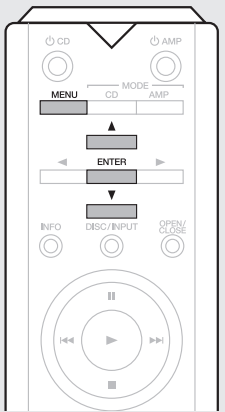

NOTE

With the “Direct” setting, you can use the Play, Pause, Next, Previous, and Stop commands from the remote control.

USB Resume (Playing tracks from where they were previously stopped)

1 Use Δ / ∇ to select “USB Resume” and press **ENTER**.

2 Use Δ / ∇ to select resume playback on / off and press **ENTER**.

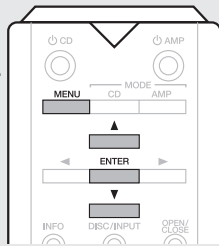

[Selectable modes]

Off :Resume playback is not set.

On :Resume playback is set.

3 Press **MENU**.
Saves the settings.

NOTE

- Resume Play only works when an identical USB memory device is inserted. If another USB memory device is inserted, the unit will start playing from the first file.
- The unit may not play your desired file if files have been added to or deleted from the identical USB memory device.

Digital Out (Setting for the digital output)

1 Use Δ / ∇ to select “Digital Out” and press **ENTER**.

2 Use Δ / ∇ to select on / off and press **ENTER**.

[Selectable modes]

On :Enable the digital output.

Off :Disable the digital output.

3 Press **MENU**.
Saves the settings.

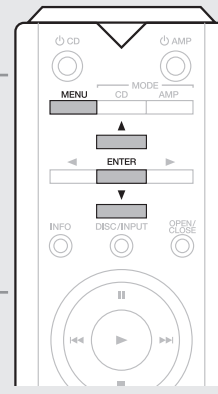

Phase (analog output phase switching)

Switches the output signal phase for balanced outputs. The unit's balanced output conforms to USA system. This setting must be set to “Inverted” in order to execute balanced outputs to a European system amplifier with a different (inverted) phase.

1 Use Δ / ∇ to select “Phase” and press **ENTER**.

2 Use Δ / ∇ to select the phase corresponds to the amplifier and press **ENTER**.

[Selectable modes]

Normal : USA system.

Inverted : European system.

3 Press **MENU**.
Saves the settings.

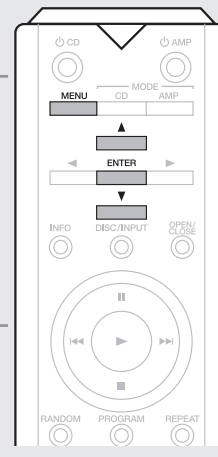

Auto Stnby (Auto standby mode)

A standby status is established at the unit if a stopped status or a “no external input signal” status continues for 30 minutes or more.

1 Use Δ / ∇ to select “Auto Stnby” and press **ENTER**.

2 Use Δ / ∇ to select on / off and press **ENTER**.

[Selectable modes]

On :Enable Auto Standby mode.

Off :Disable Auto Standby mode.

3 Press **MENU**.
Saves the settings.

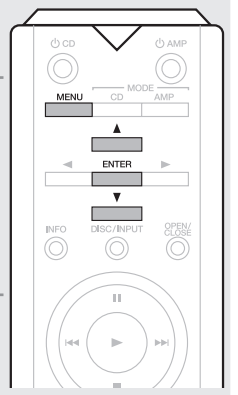

NOTE

When the Input Source of this unit is set to “PC”, the Auto Standby function may not work properly depending on the applications of your PC.

Explanation of terms

B

Bit rate

This expresses the read amount per 1 second of video/audio data recorded in a disc.

M

MP3 (MPEG AudioPlayer 3)

This is an internationally standardized audio data compression scheme, using the "MPEG-1" video compression standard. It compresses the data volume to about one eleventh its original size while maintaining sound quality equivalent to a music CD.

S

Sampling frequency

Sampling involves taking a reading of a sound wave (analog signal) at regular intervals and expressing the height of the wave at each reading in digitized format (producing a digital signal).

The number of readings taken in one second is called the "sampling frequency". The larger the value, the closer the reproduced sound is to the original.

Super Audio CD

There are three types of Super Audio CDs:

- ① Single layer discs
Single layer Super Audio CD with just an HD layer.
- ② Dual layer discs
Super Audio CD with a double HD layer, offering extended playing time and high sound quality.
- ③ Hybrid discs
Two-layer Super Audio CD with an HD layer and a CD layer. The signals on the CD layer can be played on a regular CD player.

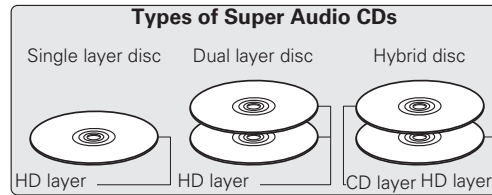

• What is the HD layer?

The HD layer is a layer of high density signals for Super Audio CDs.

• What is the CD layer?

The CD layer is the layer of signals that can be read on a regular CD player.

W

WMA (Windows Media Audio)

This is audio compression technology developed by Microsoft Corporation.

WMA data can be encoded using Windows Media® Player Ver.7, 7.1, Windows Media® Player for Windows® XP and Windows Media® Player 9 Series.

To encode WMA files, only use applications authorized by Microsoft Corporation. If you use an unauthorized application, the file may not work properly.

Troubleshooting

If a problem occurs, first check the following:

1. Are the connections correct?

2. Is the unit being operated as described in the owner's manual?

If this unit does not operate properly, check the items listed in the table below. If the problem persists there may be a malfunction.



In this case, disconnect the power immediately and contact the retail outlet.

Problem	Cause	Corrective action	Page
The disc fails to rotate.	•The power cord is pulled out of the socket.	•Insert the power cord plug into the socket.	11
	•Power to this unit is not ON.	•Turn the power to this unit ON.	12
	•The disc is not placed in the correct position on the disc tray.	•Place the disc in the disc tray correctly.	3
	•The disc is placed in upside down. (The disc is placed in with the label facing down).	•Place the disc in the disc tray correctly.	3
The disc stops rotating in mid-operation.	•The disc is dirty.	•Clean the disc's surface.	4
	•The disc is scratched.	•The disc may be unable to be played if it has a lot of scratches.	–
	•The disc is warped.	•The disc may be unable to be played if it is badly warped.	–
The disc is rotating but no sound is heard.	•The amplifier and speakers are not connected correctly.	•Connect the cables correctly. (See the instruction manual for the amplifier.)	8,9
	•The amplifier power is not ON.	•Turn ON the power to the amplifier. (See the instruction manual for the amplifier.)	–
	•The amplifier's function or selector switch is not set to "CD" or "AUX" or such (to whatever you have connected this unit to).	•Switch the amplifier's function or selector switch to "CD" or "AUX" or such (to whatever you have connected this unit to). (See the instruction manual for the amplifier.)	–
	•The amplifier's volume control is set at the minimum level.	•Adjust the amplifier volume. (See the instruction manual for the amplifier.)	–

Problem	Cause	Corrective action	Page
Remote control operation is not possible.	•This unit is too far away from the remote control.	•Move closer to this unit, and operate the remote control within the operating range.	4
	•There is an obstacle between this unit and the remote control.	•Remove the obstacle.	4
	•The remote control's batteries are dead.	•Replace all batteries with new ones.	4
	•A strong light is hitting the unit's sensor window.	•Do not let strong light hit the sensor window.	4
	•The switch on the back of the REMOTE CONTROL is on EXT.	•When using this unit independently, set the switch to INT.	11
CD-R/CD-RW disc cannot be played.	•This unit is in the amplifier operation mode.	•Press the MODE CD button to switch the operation mode.	7
	•The disc is placed in upside down.	•Place the disc in the tray correctly.	3
Cannot switch the sound mode of an SA-CD hybrid layer disc.	•The information recorded is not in an audio (CD-DA) format. Or the MP3/WMA file was not properly recorded.	•Record correct information that is compatible with this unit.	3,16
	•Start Sound Mode is set to CD.	•Change Start Sound Mode setting to Super Audio CD.	12
Sound is too quiet when signals are output from a PC.	•The PC volume is turned down.	•Turn the PC volume up.	20
No sound comes out of the headphone.	•The headphone output is disabled.	•Press the PHONES button to enable the headphone output.	14

[USB/iPod]

Problem	Cause	Corrective action	Page
"USB OC" appears on the display.	<ul style="list-style-type: none"> The voltage able to be supplied from this unit via the USB memory device has been exceeded. 	<ul style="list-style-type: none"> The USB memory device is not supported. Please use a USB memory device with an operating current that is less than 1 A. To clear the "USB OC", remove the USB memory device and turn this unit off and on. 	–
"Empty" appears on the display.	<ul style="list-style-type: none"> No file able to be played on this unit exists. 	<ul style="list-style-type: none"> Check supported formats. 	18
The sound of the USB memory device being connected is not heard.	<ul style="list-style-type: none"> The amplifier and speakers are not connected properly. 	<ul style="list-style-type: none"> Connect the cables correctly. (See the instruction manual for the amplifier.) 	–
	<ul style="list-style-type: none"> The amplifier power is not ON. 	<ul style="list-style-type: none"> Turn the amplifier power ON. (See the instruction manual for the amplifier.) 	–
	<ul style="list-style-type: none"> The amplifier's function or selector switch is not set to "CD" or "AUX" or such (to whatever you have connected this unit to). 	<ul style="list-style-type: none"> Switch the amplifier's function or selector switch to "CD" or "AUX" or such (to whatever you have connected this unit to). (See the instruction manual for the amplifier.) 	–
	<ul style="list-style-type: none"> The amplifier's volume control is set at the minimum level. 	<ul style="list-style-type: none"> Adjust the amplifier volume. (See the instruction manual for the amplifier.) 	–

Problem	Cause	Corrective action	Page
The sound of the iPod being connected is not heard.	<ul style="list-style-type: none"> The amplifier and speakers are not connected correctly. 	<ul style="list-style-type: none"> Connect the cables correctly. (See the instruction manual for the amplifier.) 	10
	<ul style="list-style-type: none"> The amplifier power is not ON. 	<ul style="list-style-type: none"> Turn ON the power to the amplifier. (See the instruction manual for the amplifier.) 	–
	<ul style="list-style-type: none"> The amplifier's function or selector switch is not set to "CD" or "AUX" or such (to whatever you have connected this unit to). 	<ul style="list-style-type: none"> Switch the amplifier's function or selector switch to "CD" or "AUX" or such (to whatever you have connected this unit to). (See the instruction manual for the amplifier.) 	–
The sound of the iPod being connected is not heard.	<ul style="list-style-type: none"> The amplifier's volume control is set at the minimum level. 	<ul style="list-style-type: none"> Adjust the amplifier volume. (See the instruction manual for the amplifier.) 	–
	Reading of USB memory device takes time.	<ul style="list-style-type: none"> When connecting a high-capacity USB memory device, it will take time to read depending on its capacity. Several minutes may be required for reading when using a high-capacity device. 	<ul style="list-style-type: none"> Wait until reading is completed.
Power fails to switch on when the remote controller's  CD is pressed.	<ul style="list-style-type: none"> The unit's power switch is off. 	<ul style="list-style-type: none"> Press the unit's power operation switch. 	12
		<ul style="list-style-type: none"> Or, press the unit's power operation switch, then press the remote controller's  CD. 	12

Specifications

□ Audio performance	[Super Audio CD]	[CD]
• Analog output		
Channels:	2 channels	2 channels
Playable frequency range:	2 Hz – 100 kHz	2 Hz – 20 kHz
Playable frequency response:	2 Hz – 50 kHz (–3 dB)	2 Hz – 20 kHz
S/N:	109 dB (Audible range)	110 dB
Dynamic range:	109 dB (Audible range)	100 dB
Harmonic distortion:	0.0009 % (1 kHz, Audible range)	0.0015 % (1 kHz)
Wow & flutter:	Crystal accuracy	Crystal accuracy
• Output level		
Unbalanced:	2.3 V RMS stereo	2.3 V RMS stereo
Headphone output:	35 mW / 32 Ω (variable maximum)	35 mW / 32 Ω (variable maximum)
• Digital output		
output level (cinch JACK):	—	0.5 Vp-p (75 Ω)
output level (optical):	—	-19 dBm
• Optical Readout System		
Laser:	AlGaAs	AlGaAs
Wave length:	650 nm	780 nm
Signal type:	1-bit DSD	16-bit Linear PCM
Sampling frequency:	2.8224 MHz	44.1 kHz
□ General		
Power supply:	AC 120 V, 60 Hz	
Power consumption:	45 W	
	Standby: 0.3 W or less	
Operating temperatures:	+5 °C – +35 °C	
Operating humidity:	5 – 90 % (without dew)	
* For purposes of improvement, specifications and design are subject to change without notice.		

Index

Numerics

1-track repeat 14

A

All-track repeat 14
Analog connections (UNBALANCED) 8
Auto standby mode 24

B

Batteries 4
Bit rate 16, 18, 25

C

Cable 8
 Audio cables 8
 Balanced audio cable 8
 Coaxial digital cable 8
 iPod cable 8
 Optical cable 8
 Power cord 11
 Remote connector cord 8
 USB cable 8
CD layer 25
CD-R/CD-RW 3, 16
Connections 8
 Analog connections (BALANCED) 9
 Analog connections (UNBALANCED) 8
 Coaxial digital cable 8
 iPod 10
 Optical cable 8
 PC 11
 Power cord 11
 Remote control connections 8
 USB memory device 10

D

D/A converter 21
DC filter function 21
Digital Out 24
Direct searching 13
Disp Info 23
Display 5
Dual layer discs 25

E

EXTERNAL 11

F

Fast-Forwarding 13, 19
Fast-Reversing 13, 19
Filter characteristics 21
Finalize 3

H

HD layer 25
Hybrid discs 25

I

INTERNAL 11
iPod Ctrl 23
iPod operation 23

M

MP3 16, 18, 25
Music CDs 3

N

Noise shaper function 21

O

Optical digital connection 9

P

Phase 24
Playback
 CD 13
 iPod® 17
 Program 15
 Random 15, 19
 Repeat 14, 19
 Stopping 13, 19
 USB memory device 18
Playback layer 12
Play File 23
Power cord 11
Program playback 15

R

Random playback 15, 19
Remote control 4
 Inserting the batteries 4
Remote control connections 8
Repeat playback 14, 19

S

Sampling frequency 16, 18, 25
Searching 13, 19
Single layer discs 25
Skipping 13
Sound mode 12
Start sound mode 13
Stopping digital outputs 15
Stopping Playback 13, 19
Stopping Playback temporarily 13, 19
Super Audio CD 3, 25
Switching the input source 12

T

Timer Play 22

U

USB memory device 16
USB Resume 24

W

WMA 16, 18, 25

Dimensions / Dimensions / Dimensions

Unit / Unité / Unidad : inch (mm)

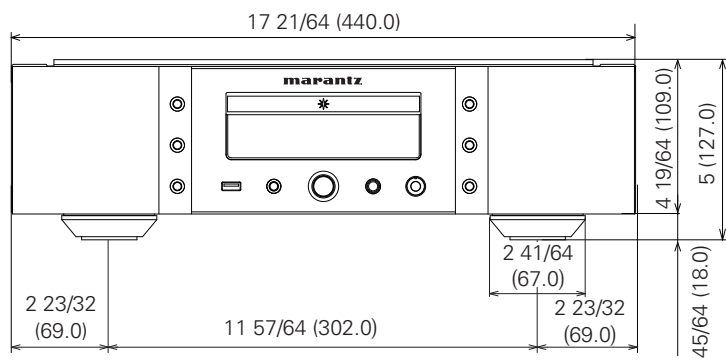
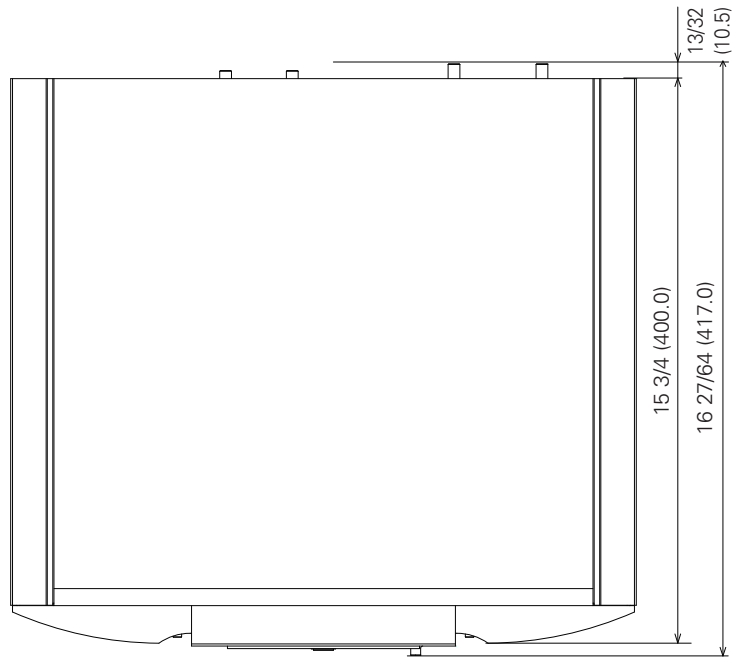

Weight / Poids / Peso : 36 lbs 6.02 oz (16.5 kg)

www.marantz.com

You can find your nearest authorized distributor or dealer on our website.

marantz[®] is a registered trademark.